

1100T Series Wireless Translator

INSTALLATION AND PROGRAMMING GUIDE

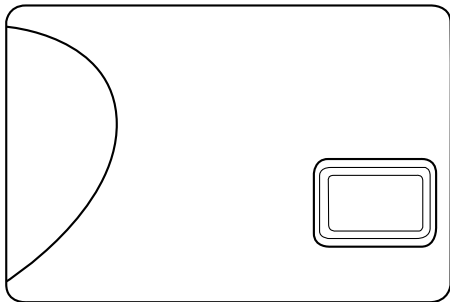

TABLE OF CONTENTS

About the Translator	1	Product Specifications	14
Learn Feature.....	1	Compatibility	15
Tamper.....	1	Full Compatibility Guide.....	15
Translator Features	2	Accessories	16
Pre-Installation	3	Certifications	17
Install the Translator	3	Intertek (ETL Listed).....	17
Wire the Power Supply	3	Patents.....	17
Program Device Setup	4	Ordering Information	17
Select a Location for the Translator.....	5	FCC Information	18
Program Zone Information	5	Industry Canada Information	19
Mount the Translator	7		
Walk Test.....	8		
Additional Information	10		
Replace the Battery.....	10		
Status LEDs	11		
1100T Supported Zones	12		
Non-DMP Sensor Supervision Time	12		
Compliance Listing Specifications	13		
Commercial Fire.....	13		

ABOUT THE TRANSLATOR

The 1100T Wireless Translator allows upgrades of non-DMP systems with one way, low frequency, wireless transmitters to DMP. The 1100T is compatible with transmitters that operate at various MHz such as Interlogix, Honeywell 5800, 2GIG, and DSC.

The translator operates with a wireless connection to a DMP receiver on a DMP panel and is available as an 1100T or 1100TF version.

Learn Feature

Transmitters that have been learned into the 1100T are able to send supervision and low battery messages to the panel.

Tampers

The translator is equipped with a case and wall tamper.

TRANSLATOR FEATURES

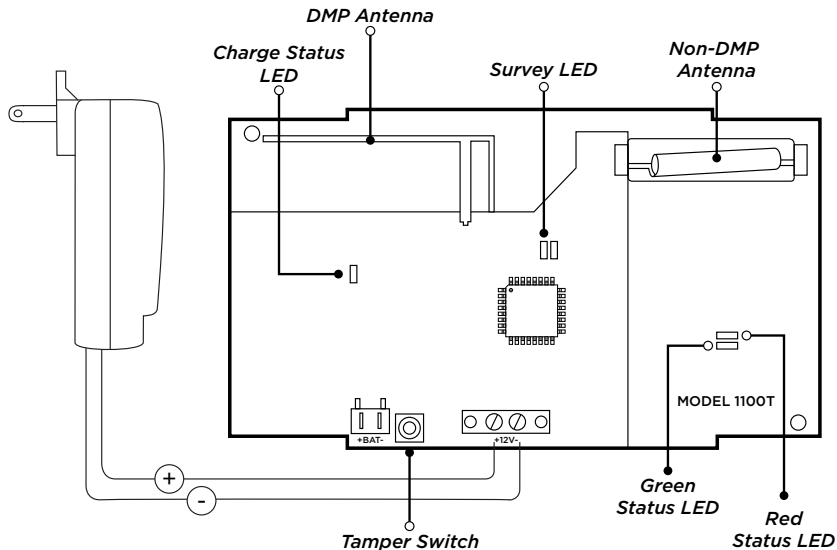

Figure 1: Product Features

PRE-INSTALLATION

Before installing the translator, the DMP panel and receiver must already be powered on and set up in their final locations. See the panel and receiver guides for their installation information.

INSTALL THE TRANSLATOR

1 *Wire the Power Supply*

The 1100T Wireless Translator can be powered from a 12 VDC external power supply. In addition to powering the translator, the power supply also charges the back-up battery. If the DC power source is removed, the power failure is indicated as an open condition on the translator device number.

The 372-500-W power supply must be located within 100 feet of the translator using 22 AWG wire. Use the following steps to connect it:

1. With the cover removed, connect the positive wire to the positive terminal on the translator.
2. Connect the negative wire to the negative terminal on the translator.
3. Plug the power supply into a wall outlet not controlled by a switch.

2 Program Device Setup

The translator must first be programmed as a device in Device Setup. Zones should be programmed in Zone Information.

1. Go to **DEVICE SETUP** and press **CMD**.
2. At **DEVICE NO**, enter the desired device number for the 1100T. Available addresses:
 - XTL Series, XT Series, or XR150: 2-8
 - XR550: 2-16
3. Select ***UNUSED*** to enter a name for the device. After naming the device, press **CMD**.
 - **XR Series and XT75 Control Panels:**
Press the fourth select key or area to change the device type.
Press **CMD** until **TLR** is displayed and select that for the translator.
 - **XT30/XT50 Control Panels:**
At **1100T? NO YES**, select **YES** and press **CMD**.
4. Enter the Serial number.
5. At **1100T FREQ**, press any select key or area to select the non-DMP system. Default is **HWL** (Honeywell).
6. At **SUPRVSN TIME**, select the supervision time required for the 1100T. DMP default supervision time is **240** minutes.
7. Press **CMD** and then the Back Arrow to exit Device Setup.

3 *Select a Location for the Translator*

The 1100T translator provides a Survey LED capability to allow one person to confirm communication with the panel while the cover is removed.



1. While remaining in panel programming, hold the translator in the exact desired location.
2. Press the tamper switch to send data to the panel and determine if communication is confirmed or faulty.

✓ **Confirmed:** If communication is confirmed, for each press or release of the tamper switch, the LED blinks immediately on and immediately off. Repeat this test 5 times to confirm ten separate consecutive LED blinks. Any indication otherwise means proper communication has not been established.

✗ **Faulty:** If communication is faulty, the LED remains on for about 8 seconds or flashes multiple times in quick succession. Relocate the translator or receiver until the LED confirms clear communication.

4 *Program Zone Information*

1. In **ZONE INFORMATION**, enter the wireless zone number.
2. At ***UNUSED***, enter the zone name.
3. Select a **ZONE TYPE**.

4. At **DMP WIRELESS**, select **NO**.
5. At **COMP WLS**, select **YES**.
6. At **COMP WLS SRL #**, either manually enter the serial number of the transmitter or transmit the serial number to the panel:
 - **Manually:** Press the first select key or area and type in the transmitter's serial number.
 - **Transmit:** Choose **LRN** at prompt to display **TRANSMIT NOW**. Tamper the transmitter. Once the panel has received the tamper signal, the serial number will display.
 -  **Note:** If programming a sensor with multiple contacts, use the appropriate serial number. See *LT-0705 1114 Wireless Four-Zone Expander Installation Guide* for programming instructions.
7. Once the serial number is entered, press **CMD**.
8. At the transmitter contact display, press a select key to choose from contact 1, 2, 3, or 4. Default is **1**.
 -  **Note:** If programming a sensor with one contact, leave the transmitter contact option at the default.
9. At the transmitter supervision time, press a select key to choose from 0H, 4H (if zone type is FI, CO, or SUPV), 12H, or 24H. Default is **24H**.
10. Save and exit programming.

5 Mount the Translator

The translator must be mounted using the provided #6 screws in the four mounting holes. Mount the translator in a secure, dry place away from metal objects to protect the unit from damage due to tampering or the elements. Mount the translator a minimum of 4 feet from any wireless panels or receivers. It is necessary to remove the PCB when installing the enclosure. Refer to Figure 2 in the following steps.

1. With the cover removed, use the included #6 screws to secure the 1100T to the wall.
2. Use one of the provided screws to secure the wall tamper.

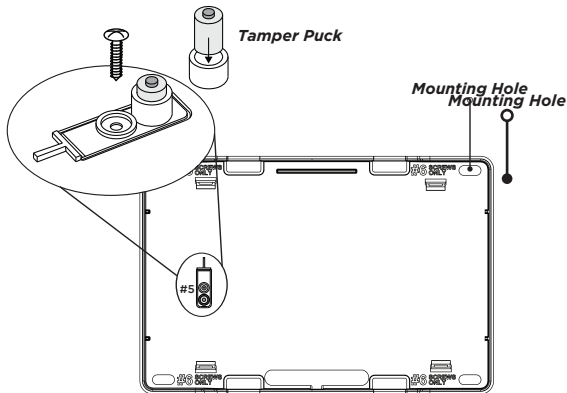

Figure 2: Inside of the 1100T Housing

6 Walk Test

To test the system, perform a standard walk test. Non-DMP wireless devices are not compatible with the DMP Wireless Walk Test. See the panel programming guides for more information.

XR Series and XT75 Control Panels

1. Reset the control panel by placing and removing a jumper on **RESET**.
2. At the keypad, enter **8144** (WALK).
3. Select the zone type you want to test. An asterisk indicates the chosen zone type. Press the select key or area again to deselect the zone type. When you have selected all the zone types you want for testing, press **CMD**.



Note: For the purpose of the Walk Test, do not select **WLS** or **PIR**. These options are not compatible.

4. Select **BELL**. This option is for when a zone under test faults. This option allows the panel bell, and/or burglary bell, and/or fire bell to turn on and then off each time a zone is tripped.
 - **NO** - Select for no bell output action during Walk Test.
 - **YES** - Select to turn on any bell output for 2 seconds during Walk Test.
 - **PULS** - Select to turn on any bell output for 1/4 second during Walk Test.
5. Once in the Walk Test, walk around and trip each protective device. Continue tripping devices until the entire system is tested.
6. Press the select key or area directly below **END** to stop the Walk Test.

XT30/XT50 Control Panels

1. Reset the control panel by placing and removing a jumper on **RESET**.
2. From the keypad, enter **8144** (WALK).
3. Select **STD** to test all programmed zones.
4. Once in the Walk Test, walk around and trip each protective device. Continue tripping devices until the entire system is tested.
 - Each time a selected zone trips, the keypad buzzes and the bell rings for two seconds.
 - Each time a **FI**, **FV**, **SV**, or **CO** zone trips, a Sensor Reset occurs.
5. Press the select key or area directly below **END** to stop the Walk Test.

ADDITIONAL INFORMATION

Replace the Battery

DMP recommends replacing the battery every three years.

1. Open the translator housing to expose the inside of the 1100T.
2. Remove the PCB board
3. Unplug the battery connector, then remove the old battery
4. Connect the battery connector
5. Snap the PCB Board back in place.
6. Snap the cover back on the 1100T.

Status LEDs

The green and red status LEDs in the lower right corner of the 1100T provide visual indication of DMP 1100 wireless synchronization status.

- Green ON and red OFF indicates the 1100T is in sync with the DMP 1100 wireless receiver.
- Green OFF and red ON means the 1100T is not in sync with the receiver.
- If the green is OFF and red flashes every 1/4 second, the 1100T should be power cycled manually.

The charge status LED is hardware controlled and will be ON when the battery is connected and charging. It will be OFF when the battery is connected and fully charged. Flashing once a second indicates a charge controller fault which will occur if the battery is disconnected.

1100T Supported Zones

The supported zones per DMP panel are as follows:

DMP PANEL	AVAILABLE ZONES	ZONE RANGES
XTLplus and XTLtouch	99	1 - 99
XT50 with built-in receiver	48	11 - 14, 21 - 24, 31 - 34, 41 - 44, 51 - 54, 61 - 64, 71 - 74, 81 - 84, 80, 85 - 99
XT30 and XT50 (1100XD Series)	32	11 - 14, 21 - 24, 31 - 34, 41 - 44, 51 - 54, 61 - 64, 71 - 74, 81 - 84
XT75 (1100XH Series)	100	500 - 599
XR150 (1100XH Series)	100	500 - 599
XR550 (1100XH Series)	128	Any unused zone between 500 and 999

Non-DMP Sensor Supervision Time

Default Supervision time for Non-DMP sensors is 24 Hours. Additional supervision times available include:

- 0 H
- 4 H - Fire, CO, or Supervisory zone type
- 12 H

Follow manufacturer guidelines for supervision times required on non-DMP sensors.

COMPLIANCE LISTING SPECIFICATIONS

Commercial Fire

Power Supply

When using the Model 372-500-W plug-in power supply for Commercial Fire installations, mount the 1100T on a UL-listed gangbox and connect by conduit to a listed transformer enclosure such as the ES501 or ES502.

Install the enclosure by removing the two screws from the outlet and inserting them through the back of the enclosure. Install conduit fittings, connect wiring, and install the power supply. Secure the enclosure cover with two screws. See Figure 3.

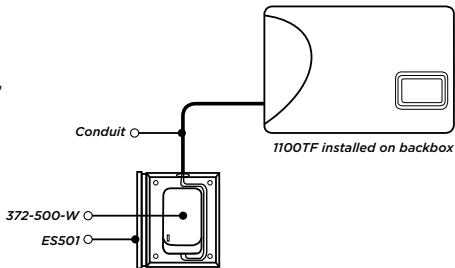

Figure 3: Power Supply with Enclosure Wiring

Battery

The 9800BAT2400 provides 24-hour standby operation for Commercial Fire installations. Install the 1100TF in accordance with NFPA 70 and NFPA 72 Chapter 29.

Supervision Time

1100T and Non-DMP Sensor supervision time must be set to 4 hours or less.

PRODUCT SPECIFICATIONS

Operating Voltage	12 VDC, 31 mA
Standby Battery	
<i>1100T</i>	
Voltage	3.7 VDC
Type	Lithium Polymer, rechargeable
Capacity	800 mAh
Standby	4 hours
<i>1100TF</i>	
Voltage	3.7 VDC
Type	Lithium Polymer, rechargeable
Capacity	2400 mAh
Standby	24 hours
Frequency Range	905-924 MHz
Dimensions	5.50" W x 3.75" H x 1.00" D 13.97cm W x 9.53 cm H x 2.54 cm D
Temperature	32 ° - 120 ° F
Humidity	93%

COMPATIBILITY

- XTL Series Control Panels
- XT Series Control Panels
- XR Series Control Panels
- All 1100 Series Wireless Receivers with versions 207 or higher
-  **Warning:** The 1100T Wireless Translator is not compatible with systems using the 1100R Wireless Repeater.
- Interlogix 319.5 MHz
- Honeywell 5800 345 MHz
- 2GIG Series 345 MHz
- DSC 433 MHz
- Encryption requires panel Version 211 or higher and Wireless Receiver Version 301 or higher
- Remote Link Version 2.11 (3/2/21) or higher



Full Compatibility Guide

For a full list of compatible non-DMP products, see the [1100T Wireless Translator Compatibility Guide LT-2430](#). Scan the QR code below if viewing this in a printed manual.

ACCESSORIES

BAT800/8	Replacement rechargeable battery (8 pack)
BAT2400/8	Battery for Commercial Fire (24-hour Standby)
505-12	12 VDC Power Supply
372-500-W	Plug-In DC Power Supply
ES501	Transformer Enclosure (4.25 W x 5.625 H x 2.5 D inches)
ES502	Transformer Enclosure (4.25 W x 5.625 H x 3.75 D inches)

CERTIFICATIONS

FCC ID: CCKPC0225

IC: 5251A-PC0225

Intertek (ETL Listed)

UL 864	Control Units and Accessories for Fire Alarm Systems
UL 985	Household Fire Warning System
UL 1023	Household Burglar Alarm System Units
UL 2610	Commercial Premises Security Alarm Units and Systems

Patents

U.S Patent No. 7,239,236 DMP Wireless Sensors

ORDERING INFORMATION

1100T	Wireless Translator
1100TF	Wireless Translator with 24-hour standby battery for Fire Applications

FCC INFORMATION

This device complies with Part 15 of the FCC Rules. Operation is subject to the following two conditions:

1. This device may not cause harmful interference, and
2. This device must accept any interference received, including interference that may cause undesired operation.

Changes or modifications made by the user and not expressly approved by the party responsible for compliance could void the user's authority to operate the equipment.



Note: This equipment has been tested and found to comply with the limits for a Class B digital device, pursuant to part 15 of the FCC Rules. These limits are designed to provide reasonable protection against harmful interference in a residential installation. This equipment generates, uses and can radiate radio frequency energy and, if not installed and used in accordance with the instructions, may cause harmful interference to radio communications. However, there is no guarantee that interference will not occur in a particular installation. If this equipment does cause harmful interference to radio or television reception, which can be determined by turning the equipment off and on, the user is encouraged to try to correct the interference by one or more of the following measures:

- Reorient or relocate the receiving antenna.
- Increase the separation between the equipment and receiver.
- Connect the equipment into an outlet on a circuit different from that to which the receiver is connected.
- Consult the dealer or an experienced radio/TV technician for help.

INDUSTRY CANADA INFORMATION

This device complies with Industry Canada License-exempt RSS standard(s). Operation is subject to the following two conditions:

1. This device may not cause interference, and
2. This device must accept any interference, including interference that may cause undesired operation of the device.

Le présent appareil est conforme aux CNR d'Industrie Canada applicables aux appareils radio exempts de licence. L'exploitation est autorisée aux deux conditions suivantes:

1. l'appareil ne doit pas produire de brouillage, et
2. l'utilisateur de l'appareil doit accepter tout brouillage radioélectrique subi, même si le brouillage est susceptible d'en compromettre le fonctionnement.

Information furnished is believed to be accurate and reliable.
This information is subject to change without notice.

