

738Zplus Z-WAVE INTERFACE MODULE

Installation Guide

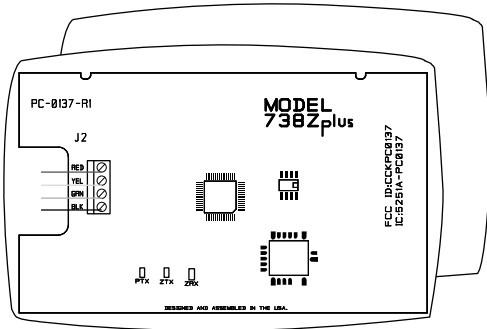

Figure 1: 738Zplus Z-Wave Interface Module

DESCRIPTION

The 738Zplus Z-Wave Interface Module allows DMP panels to communicate with up to 140 Z-Wave or Z-Wave Plus devices, such as light controls, light bulbs, door locks, garage door openers, and thermostats.

The 738Zplus is automatically recognized by DMP panels, and no additional programming is required. Once the 738Zplus is connected to a DMP panel, users can immediately begin adding Z-Wave devices to their system.

Devices can be remotely controlled from smart phones using the DMP Virtual Keypad™ App.

What is Included?

- 738Zplus Z-Wave Interface Module
- Hardware pack

1 SELECT THE LOCATION

Select a central location for the 738Zplus Z-Wave Interface Module. Keep in mind that at least one Z-Wave Plus device must be within 65 feet of the 738Zplus. Most Z-Wave Plus devices act as repeaters for the signal to create longer and multiple transmission routes (battery-powered Z-Wave Plus devices do not repeat signals in order to extend battery life). See Figure 2.

Note: Place the module away from large, metal objects to avoid interference with the Z-Wave Plus signal.

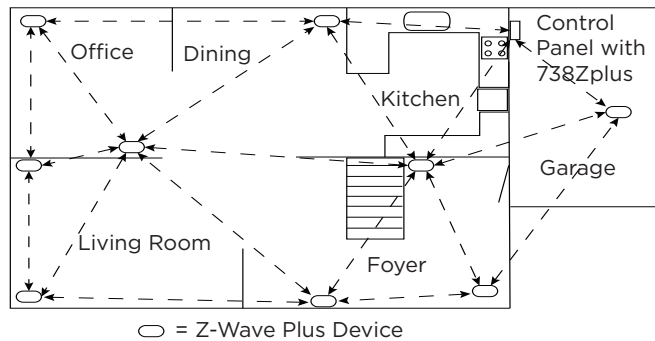

Figure 2: Example Z-Wave Plus Transmission Routes

2 MOUNT THE 738Zplus

1. With the housing cover off, carefully remove the 738Zplus's PCB from the housing.
2. Use the supplied screws to secure the 738Zplus housing against a wall or flat surface. See Figure 3.

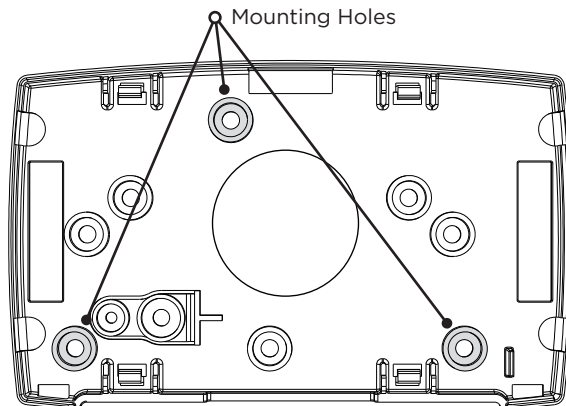

Figure 3: 738Zplus Housing with Mounting Holes

3 WIRE THE 738Zplus

The 738Zplus has four wire connections to connect to the panel's keypad bus. See Figure 4.

1. Connecting the wires to the 738Zplus terminals.
 - a. Connect the wire that delivers power to the module to the **RED** terminal.
 - b. Connect the wire that sends data from the module to the **YEL** terminal.
 - c. Connect the wire that receives data from the panel to the **GRN** terminal.
 - d. Connect the ground wire to the **BLK** terminal.
2. Carefully place the 738Zplus PCB back into the housing, and then snap the housing cover into place.
3. At the panel, connect the wires to the keypad bus corresponding terminals.

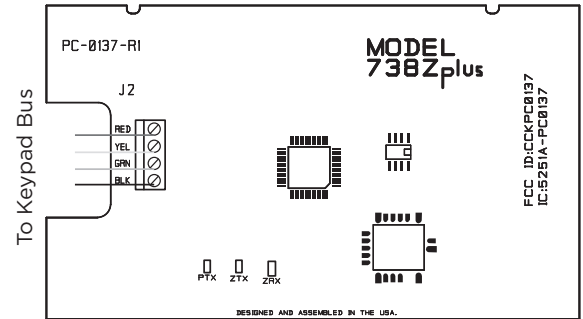

Figure 4: 738Zplus Module Wiring Connections

4 ADD DEVICES

After wiring the 738Zplus to the panel, use a DMP keypad to program Z-Wave Plus devices into the panel through the User Menu Z-Wave Setup option. This allows users to add devices through the User Menu or the Virtual Keypad™ app after installation. When possible, have the Z-Wave device near the 738Zplus during setup and programming.

When programming Z-Wave devices into an XT30, XT50, or XTLplus panel with Version 171 or higher, you can add multiple devices at once. If you add multiple devices at once, then you will name each device after they have all been added.



Note: To add the 738Zplus to an existing network, use the **LRN** (Learn) function.

1. Press **CMD** until **MENU? YES NO** appears, then press **YES**.
2. Press **CMD** until **ZWAVE SETUP?** appears. Press any select key or area.
3. Select **ADD**. The screen displays **PROCESSING**.
4. When prompted, press the button (or series of buttons if adding a thermostat) on the device you are adding.
5. The keypad displays that the device has connected to your system.

5 REMOVE OR REPLACE DEVICES

If a device fails, users can remove or replace the device through the User Menu.

1. Press **CMD** until **MENU? YES NO** appears, then press **YES**.
2. Press **CMD** until **ZWAVE SETUP?** appears. Press any select key or area.
3. Select **LIST** and press **CMD** until the device you are removing or replacing displays. Then, press any select key or area to select the device.
4. Select **STATUS**. The status of the device displays as either **OKAY** or **FAILED**. If the device fails, **REMOVE FAILED DEVICE** displays.
5. Select **YES** to remove the device. Press the second select key or area to replace the device.
6. If you chose to replace the device, **PROCESSING** displays.
7. When prompted, press the button (or series of buttons if adding a thermostat) on the replacement device.
8. The keypad displays that the device has connected to your system.



Note: The replacement device keeps the original device's name.

ADDITIONAL INFORMATION

LED Operation

The 738Zplus has three LEDs on the PCB that allow you to determine what type of operation is occurring. See Figure 4 for LED locations.

- *PTX Green LED* - If the light is blinking, then data is being sent to the panel.
- *ZTX Green LED* - If the light is blinking, then data is being sent to Z-Wave Plus devices.
- *ZRX Yellow LED* - If the light is blinking, then data is being received from Z-Wave Plus devices.

Z-Wave Terminology

Primary Controller: This is the main device used to set up and control your Z-Wave network. There can only be one primary controller and it can be used to add or delete devices. A primary controller can be a portable device like a hand-held remote, a static controller (permanently installed & never moved), a Z-Wave enabled PC or a Z-Wave enabled Ethernet router/bridge.

Secondary Controller: The Z-Wave network supports multiple controllers so that additional Z-Wave remote controllers can be used throughout the home. If the secondary controller is the same brand and model as the primary, it will have all the same capabilities as the primary.

Home Control Network: The controllers and every Z-Wave device added with the primary controller are linked together into a wireless network. Each device in the network has a unique address assigned to it and cannot be activated by a neighbor's Z-Wave controller.

Light/Node/Device: Node is the technical term used to describe a Z-Wave device in a home control network. Please note that the terms "Node," "Device," and "Light" all refer to an individual Z-Wave enabled device and are interchangeable within the context of these instructions.

Z-Wave Certification

- The 738Zplus is a Z-Wave Security enabled device.
- The 738Zplus can be added to an existing network as a secondary controller using the Learn (LRN) process.
- The 738Zplus is compatible with Z-Wave devices from all manufacturers.
- The 738Zplus can perform a Factory Default Reset by initializing defaults in the panel programming menu.
- The 738Zplus only supports group one with a maximum of one node.
- The 738Zplus takes no action when a basic set command is received.

Initialize Defaults

Only use this procedure when the Z-Wave network primary controller is missing or otherwise inoperable. Follow these steps to initialize Z-Wave programming:

1. Reset the panel.
2. Enter **2313** (DIAG) at a keypad and press **CMD** to access the panel **DIAGNOSTIC MENU**.
3. Press **CMD** until **INIT Z-WAVE** displays and press a top row select key or area.
4. Select **YES** when **Z-WAVE? NO YES** displays. **INIT SUCCESSFUL** displays when all Z-Wave programming has been initialized.

Compatibility

- **All Z-Wave and Z-Wave Plus Devices**
- **XT30/XT50 Series Panels**
738Zplus modules connected to DMP XT30/XT50 Control Panels with Version 171 firmware or higher provide full Z-Wave Plus functionality. DMP XT30/XT50 Series panels with Version 125 or earlier provide standard Z-Wave functionality.
- **XT75 Control Panels**
- **XR150/XR550 Series Panels**
738Zplus modules connected to DMP XR Series Panels with Version 182 firmware or higher provide full Z-Wave Plus functionality. XR Series Control Panels with Version 181 or earlier provide standard Z-Wave functionality.

 **Note:** If you are upgrading firmware for an XT30/XT50 Series or an XR Series Control Panel that is already connected to a 738Zplus, you will need to initialize panel defaults to access Z-Wave Plus functionality. See the appropriate panel Programming Guide for more information on initializing defaults.

FCC INFORMATION

This device complies with Part 15 of the FCC Rules. Operation is subject to the following two conditions:

1. This device may not cause harmful interference, and
2. This device must accept any interference received, including interference that may cause undesired operation.

The antenna used for this transmitter must be installed to provide a separation distance of at least 20 cm (7.874 in) from all persons. It must not be located or operated in conjunction with any other antenna or transmitter.

Changes or modifications made by the user and not expressly approved by the party responsible for compliance could void the user's authority to operate the equipment.

 **Note:** This equipment has been tested and found to comply with the limits for a Class B digital device, pursuant to part 15 of the FCC Rules. These limits are designed to provide reasonable protection against harmful interference in a residential installation. This equipment generates, uses and can radiate radio frequency energy and, if not installed and used in accordance with the instructions, may cause harmful interference to radio communications. However, there is no guarantee that interference will not occur in a particular installation. If this equipment does cause harmful interference to radio or television reception, which can be determined by turning the equipment off and on, the user is encouraged to try to correct the interference by one or more of the following measures:

- Reorient or relocate the receiving antenna.
- Increase the separation between the equipment and receiver.
- Connect the equipment into an outlet on a circuit different from that to which the receiver is connected.
- Consult the dealer or an experienced radio/TV technician for help.

Industry Canada Information

This device complies with Industry Canada Licence-exempt RSS standard(s). Operation is subject to the following two conditions:

1. This device may not cause interference, and
2. This device must accept any interference, including interference that may cause undesired operation of the device.

Le présent appareil est conforme aux CNR d'Industrie Canada applicables aux appareils radio exempts de licence. L'exploitation est autorisée aux deux conditions suivantes : (1) l'appareil ne doit pas produire de brouillage, et (2) l'utilisateur de l'appareil doit accepter tout brouillage radioélectrique subi, même si le brouillage est susceptible d'en compromettre le fonctionnement.

This system has been evaluated for RF Exposure per RSS-102 and is in compliance with the limits specified by Health Canada Safety Code 6. The system must be installed at a minimum separation distance from the antenna to a general bystander of 7.87 inches (20 cm) to maintain compliance with the General Population limits.

L'exposition aux radiofréquences de ce système a été évaluée selon la norme RSS-102 et est jugée conforme aux limites établies par le Code de sécurité 6 de Santé Canada. Le système doit être installé à une distance minimale de 7.87 pouces (20 cm) séparant l'antenne d'une personne présente en conformité avec les limites permises d'exposition du grand public.

738Zplus Z-WAVE INTERFACE MODULE

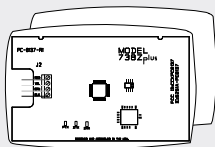

Specifications

Power Requirements	
Operating Voltage	8 to 14VDC
Current Draw	40mA
Frequency Range	908 MHz
Dimensions	4.5"W x 2.75"H x 1.75"D
Color	White
Housing Material	Flame retardant ABS

Certifications

FCC Part 15 ID:	CCKPC0137R2
Industry Canada:	5251A-PC0137R2



Designed, engineered, and
manufactured in Springfield, Missouri
© 2019 Digital Monitoring Products, Inc.
LT-1608 24401

INTRUSION • FIRE • ACCESS • NETWORKS

2500 North Partnership Boulevard
Springfield, Missouri 65803-8877

800.641.4282 | DMP.com